

SIDE STAND YS-230 for JOG / -ZR (REMOTE CONTROL JOG)

CODE	656-0010230
APPLICATION	JOG / -ZR (REMOTE CONTROL JOG) (5KN / 5PT / 5SE / 5SJ)

Thank you for purchasing Kitaco product. Read and understand the instruction before installing.

ATTENTION (MUST READ)

- ▲Pay attention to below to install side stand. Assembling mistake and improper setting may cause of trouble and accident.
- We are not responsible for violation of law or damages and accidents caused by assembling mistake and improper setting.
- Please ask authorized mechanic for assembling and setting. Ask a specialist at specialty shop if you do not understand the role of the surrounding parts.
- This product is designed and made exclusive for application models, do not use other models.
- The vehicle height is changed because of changing rear shock, etc may cause of falling because of stand degree. Please install with stock condition.
- After installation, move side stand back and forth, check the strage position and positon to stable vehicle.
- Do not shake or jump on the vehicle with using side stand. It might cause of breaking side stand, surrounding parts and accident.
- Do not over weight. It causes of falling.
- Bolts and nuts may get loosen by engine vibration. Make sure not to loosen any bolts and nuts before driving.
- Please give this instruction sheet when you sell to someone.
- Make sure not to loosen any bolts and nuts before riding. If loosen, please do additional tightening.

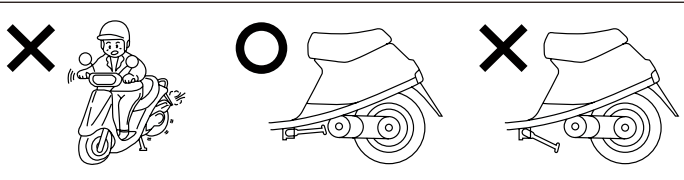
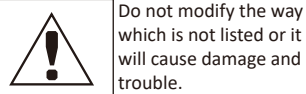
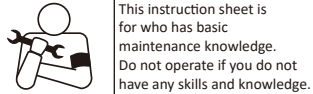

Do not start engine with using side stand. It might cause of jump out the vehicle and falling. Please storage side stand before riding.

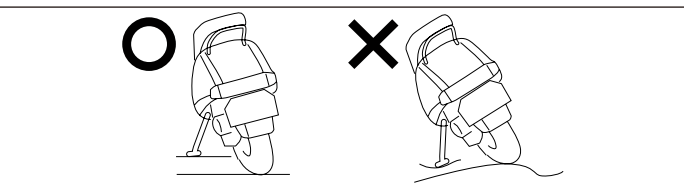

Do not use side stand on soft mud, bumpy road, etc. Check the side stand on the flat hard road to not falling before using side stand.

REQUIRED TOOL : SPANNER

PACKING LIST

FIGURE	NAME	QTY
1	STAND MAIN UNIT	1
2	NUT 8mm	2
3	SPRING WASHER 8mm	2
4	INSTRUCTION SHEET / REMARK	1

070517

INSTALLATION ILLUSTRATION

HOW TO INSTALL

- 1) Remove side cover (L) bolt (A / B / C). Before removing side cover, spray (lubrication) to a gap between floor and side cover. Therefore it ease to remove side cover because it is slippy. Pull (A / B) cover lightly. After pull, move side cover a little bit left side, and pull out not to break cover claw.
- 2) Cut the inner fender (E) on the illustration II by cutter knife. (Cutting part is from inside, dotted line on illustration II, easy to find because streaks appear due to embossing.)
- 3) Remove inner fender (D) bolt.

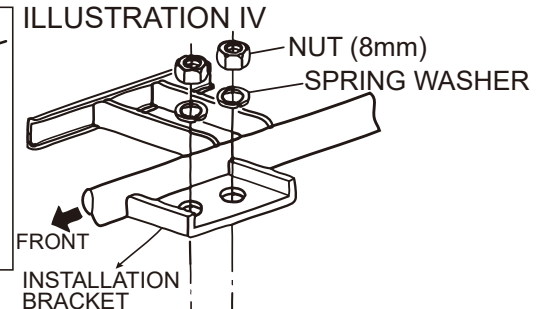
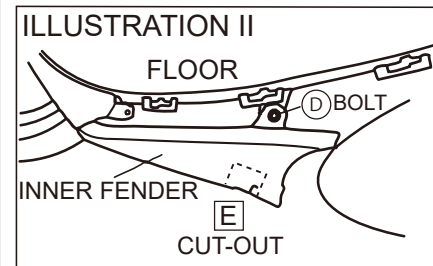
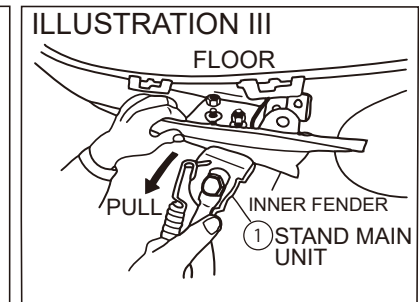
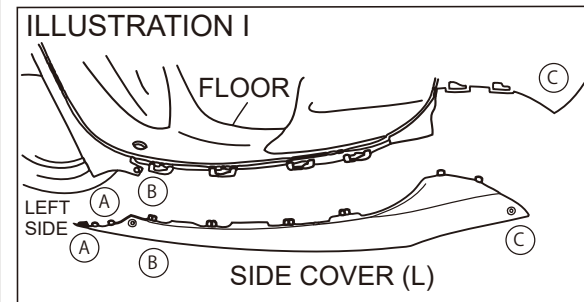

- 4) Install side stand main unit to vehicle side bracket from cut place referring to illustration III. Tighten side stand that installed while pulling inner fender to forward with spring washer (8mm) and nut (8mm) from a gap between floor and inner fender.
- 5) Put inner fender back as illustration II, tighten (D) bolt. Make sure the inner fender cut out place does not touch side stand. If it touches, please shave.
- 6) Put the side cover (L) back, tighten (A / B / C) bolt to finish installation.

