

SIDE STAND YS-231 for BASIC JOG (BJ)

CODE	656-0010231
APPLICATION	BJ (5XN-1 / 2 / 3) '03~'04 MODEL BASIC JOG
REMARK	Cannot install to BJ (5XN-4) '05 MODEL BASIC JOG

Thank you for purchasing Kitaco product. Read and understand the instruction before installing.

ATTENTION (MUST READ)

- ▲ Pay attention to below to install side stand. Assembling mistake and improper setting may cause of trouble and accident.
- We are not responsible for violation of law or damages and accidents caused by assembling mistake and improper setting.
- Please ask authorized mechanic for assembling and setting. Ask a specialist at specialty shop if you do not understand the role of the surrounding parts.
- This product is designed and made exclusive for application models, do not use other models.
- The vehicle height is changed because of changing rear shock, etc may cause of falling because of stand degree. Please install with stock condition.
- After installation, move side stand back and forth, check the strage position and positon to stable vehicle.
- Do not shake or jump on the vehicle with using side stand. It might cause of breaking side stand, surrouding parts and accident.
- Do not over weight. It causes of falling.
- Bolts and nuts may get loosen by engine vibration. Make sure not to loosen any bolts and nuts before driving.
- Please give this instruction sheet when you sell to someone.



This instruction sheet is for who has basic maintenance knowledge. Do not operate if you do not have any skills and knowledge.



Do not modify the way which is not listed or it will cause damage and trouble.

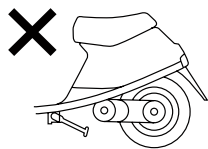
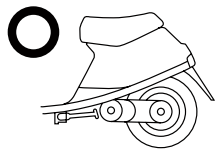
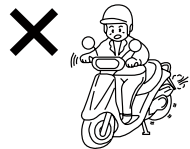

Do not start engine with using side stand. It might cause of jump out the vehicle and falling. Please storage side stand before riding.

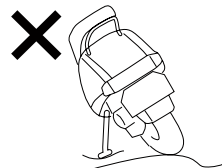
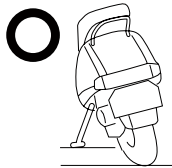

Do not use side stand on soft mud, bumpy road, etc. Check the side stand on the flat hard road to not falling before using side stand.

PACKING LIST

	NAME	QTY	NAME	QTY
1	STAND MAIN UNIT	1	8mm FLANGE NUT	1
2	STAY (mounting bracket)	1	FLAT WASHER (22 x 8.5 x T2.3)	1
3	M8 x 20 FLANGE BOLT	1	HANDSAW	1
4	M8 x 30 FLANGE BOLT	1	-	-

090831



3-8-13 NAGATA,
HIGASHI-OSAKA,
OSAKA, JAPAN
https://www.kitaco.co.jp/

INSTALLATION ILLUSTRATION

HOW TO INSTALL

- 1) Remove rear carrier, seat, side cover, left and right molding, fuel tank cap, side cover assy, battery cover, battery and foot rest board. (5XN-F8197-J0 Refer to the Yamaha service manual)

ATTENTION!

Install fuel tank cap to fuel tank again to prevent from unknown material go into fuel tank.

- 2) Cut the round tube shape part on the back side of foot rest board by attached ⑦ handsaw (from a part tip to 7mm until b part rib height).

- 3) Cut out 1~2mm inner of along to inner fender left side line. (It may already cut out depending on models.)
Water leak hole based, enlarge the hole. (Refer to the dotted line on the illustration below.)

- 4) Match the first stay ② stopper part to foot rest board stay dimple, then tighten with flange bolt ③ and flat washer ⑥. After tighten side stand assy ① by frange bolt ④ to stay, tighten side stand by flange nut ⑤.

- 5) Install removed parts in the reverse order of removing.

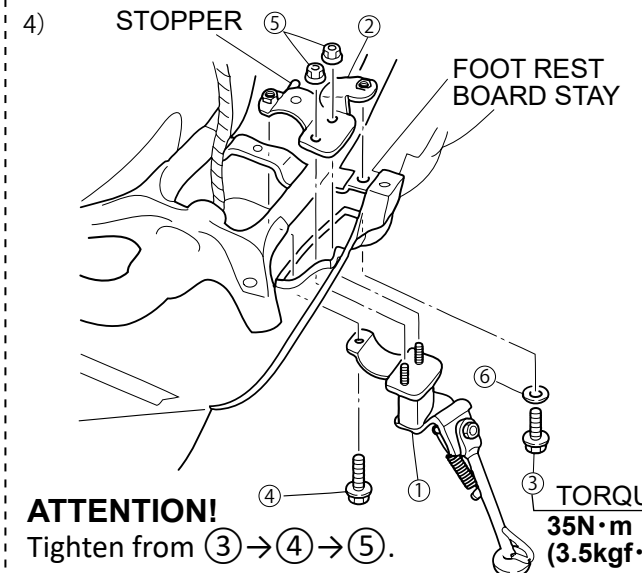
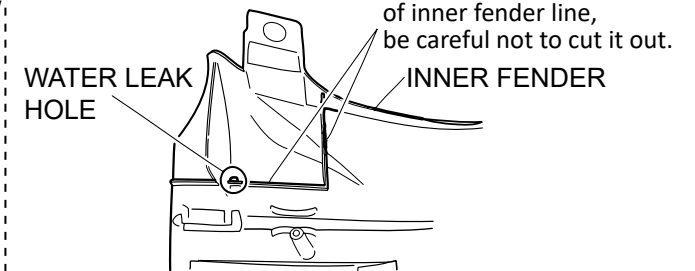
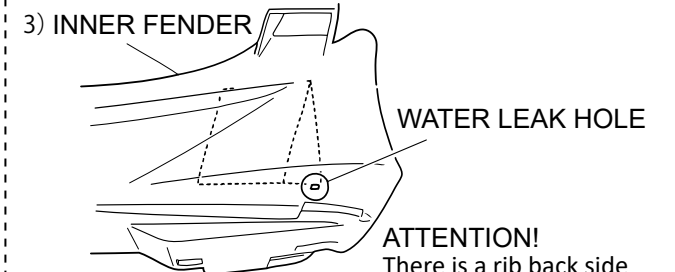
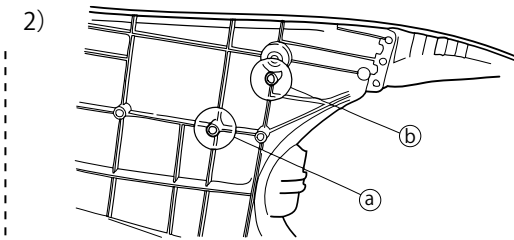

ATTENTION!

Tighten from ③ → ④ → ⑤.